

LIGHTIFY® LED A19 RGBW Lamp



Key Features & Benefits

- Home automation smart lighting controlled by smartphone or tablet
- Color changing bulb (Mixing Red, Green, Blue) and Tunable White (1900K-6500K)
- Dimmable at each set color temperature
- 60W equivalent
- LIGHTIFY System is controllable from inside the home or on the go
- Control light sources with simple to use scenes and grouping via the LIGHTIFY App
- Life: 20,000 hours rated life

Light has never been so enriching, helpful, individual and networked. OSRAM LIGHTIFY brings the future of lighting into your home or business today. Experience intelligent, connected solutions that adapt at any time to your desires and lifestyle easily via existing mobile devices and a free, simple to use app.

The LIGHTIFY lighting system begins with a wireless Gateway (sold separately or in starter kit) that can be plugged into a standard wall outlet anywhere in your home or business, and wirelessly syncs with your existing WiFi network. The LIGHTIFY LED A19 Lamp has a broad range of CCT from a warm 1900K all the way up to 6500K. The free, user-friendly LIGHTIFY App, which runs on Apple iOS7 or above and Android 4.1 or above, offers a variety of practical and playful options to control the lighting system and is simple to use, convenient and secure.

Product Offering

Ordering Description	Contains
LIGHTIFY LED A19 RGBW Lamp	1 LED A19 Lamp
LIGHTIFY Gateway	1 LIGHTIFY Wireless Gateway

Application Information

Applications

- Residential
- Small business
- Hospitality

Application Notes

1. LIGHTIFY A19 requires ZigBee Certified Gateway
2. Product activation requires active WiFi Network and ZigBee Certified Gateway (must be placed in range of wireless router)
3. Lamp turns on at 2700K
4. Free LIGHTIFY App runs on Apple iOS7 or above and Android 4.1 or above
5. 2-year limited product warranty

Specifications and Certifications

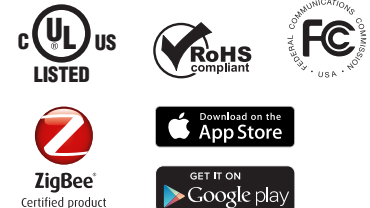

Specification Data

Catalog #	Type
Project	
Comments	
Prepared by	

Ordering Information

Item Number	Ordering Description	Wattage	Lumens	CCT	CRI	Life
73693	LED10A19RGBWLFY	10	800	1900K-6500K	80+	20,000
73692	2.4GHZ/ZB/Gateway/LFY					

LIGHTIFY® App

LIGHTIFY App: Free download on any device which runs on Apple iOS7 or above and Android 4.1 or above

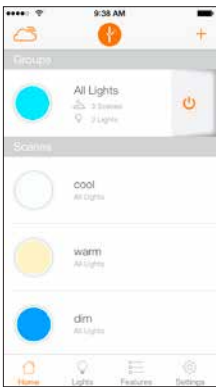

Scene Setting Dashboard

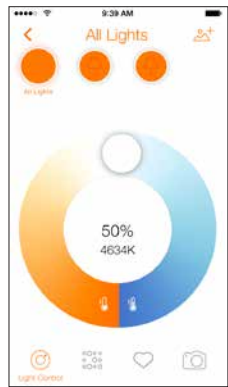

Tunable White Control

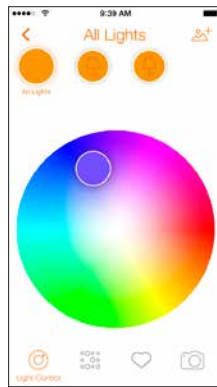

RGBW Color Control



Set schedules
for your home

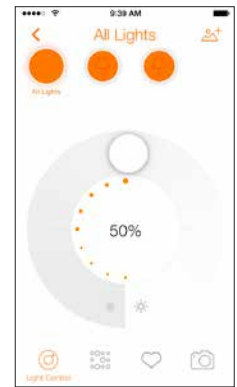

Dimmable Control

Lamp Dimensions

	(A) MOL in (mm)	(B) Diameter in (mm)
LIGHTIFY A19	4.33 (110)	2.36 (60)

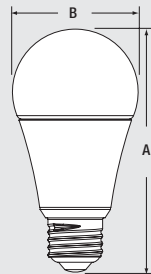

Photometric Distribution

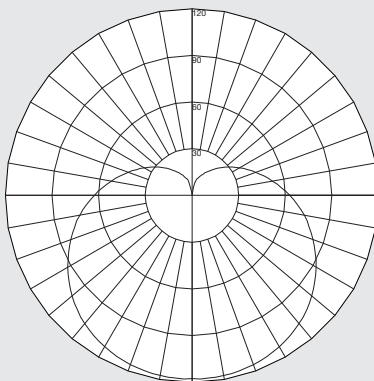

Maximum Candela = 118 Located At Horizontal Angle = 67.5, Vertical Angle = 2.5
Vertical Plane Through Horizontal Angles (260 - 80)

OSRAM SYLVANIA Inc.
200 Ballardvale Street
Wilmington, MA 01887 USA
Phone 1-800-LIGHTBULB (1-800-544-4828)
www.sylvania.com

SYLVANIA is a registered trademark of OSRAM SYLVANIA Inc.
OSRAM and LIGHTIFY are registered trademarks of OSRAM GmbH.
LED CREATING TOMORROW is a registered trademark of OSRAM GmbH.
Google Play is a trademark of Google Inc.
Apple, the Apple logo and iPhone are trademarks of Apple Inc.
App Store is a service mark of Apple Inc.
Zigbee is a registered trademark of Zigbee Alliance.
Specifications subject to change without notice.

 /sylvania  /sylvania

© 2015 OSRAM SYLVANIA



LIGHTIFY® LED BR30 RGBW Reflector Lamp



Key Features & Benefits

- Home automation smart lighting controlled by smartphone or tablet
- Color changing bulb (mixing Red, Green, Blue) and Tunable White (1900-6500K)
- Dimmable at each set color temperature
- 90+ CRI
- Replaces 65W incandescent
- Fits in most standard recessed cans
- Long 20,000 hour life rating
- LIGHTIFY System is controllable from inside the home or on the go
- Control light sources with simple to use scenes and grouping via the LIGHTIFY App

Light has never been so enriching, helpful, individual and networked. OSRAM LIGHTIFY brings the future of lighting into your home or business today. Experience intelligent, connected solutions that adapt at any time to your desires and lifestyle easily via existing mobile devices and a free, simple to use app.

The LIGHTIFY lighting system begins with a wireless Gateway (sold separately or in starter kit) that can be plugged into a standard wall outlet anywhere in your home or business, and wirelessly syncs with your existing WiFi network. The LIGHTIFY LED BR30 RGBW bulb has a broad range of CCT from a warm 1900K all the way up to 6500K. The free, user-friendly LIGHTIFY App, which runs on Apple iOS7 or above and Android 4.1 or above, offers a variety of practical and playful options to control the lighting system and is simple to use, convenient and secure.

Product Offering

Ordering Abbreviation	Wattage	Lumens	CCT
LED BR30 RGBW	11	800	1900K - 6500K

Application Information

Applications

- Residential
- Small business

Application Notes

1. LIGHTIFY BR30 requires ZigBee Certified Gateway (Sold separately)
2. Product activation requires active WiFi Network and ZigBee Certified Gateway (must be placed in range of wireless router)
3. Lamp turns on at 2700K, but can be customized using the LIGHTIFY App
4. Free LIGHTIFY App runs on Apple iOS7 or above and Android 4.1 or above
5. 2-year warranty
6. Operating temperature -20°C and +40°C (-4°F and +104°F)
7. Use in dry locations only
8. Do not install in totally enclosed fixtures
9. Lamp dims via wireless control and will not operate with a dimmer switch, remove all existing dimmers and replace with a regular switch, leave lamp in ON position

Specifications and Certifications



ZigBee
Certified product



Specification Data

Catalog #	Type
Project	
Comments	
Prepared by	

Ordering Information

Item Number	Ordering Description	Wattage	Lumens	CCT	CRI	Life
73739	LED11BR30RGBWLFY	11	800	1900K - 6500K	90+	20,000
73692	2.4GHZ/ZB/Gateway/LFY					

Ordering Guide

LED	11	BR30	RGBW	LFY
LED	Wattage: 11	Lamp Type BR30	Red, Green, Blue and Tunable White	LIGHTIFY

Lamp Dimensions

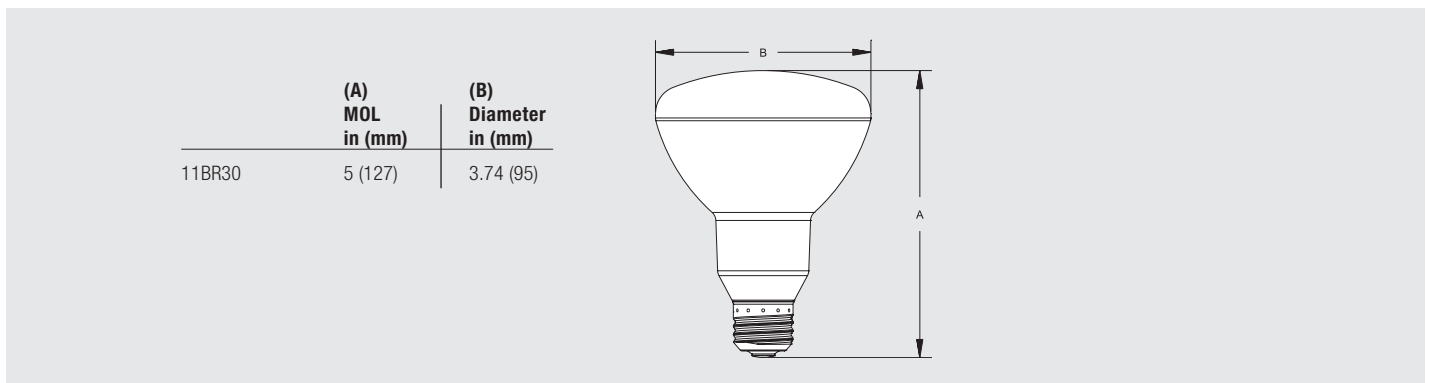

LIGHTIFY® App

LIGHTIFY App: Free download on any device which runs on Apple iOS7 or above and Android 4.1 or above

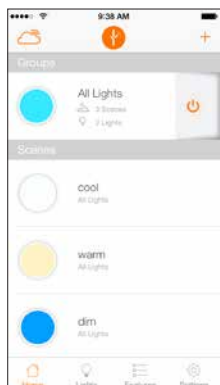

Scene Setting Dashboard

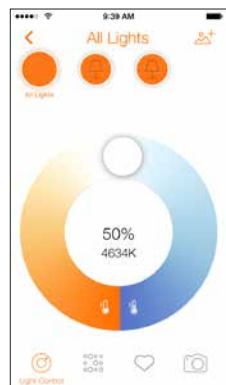

Tunable White Control



RGBW Color Control

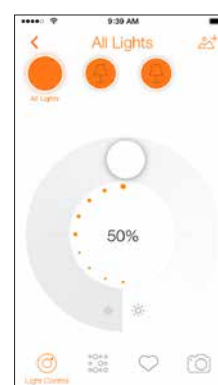

Tunable White Control
Dimmable

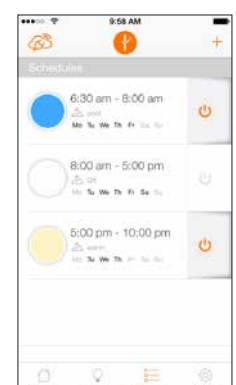

Set schedules
for your home

Photometric Distribution

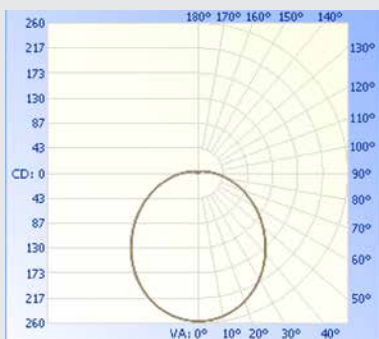

OSRAM

Americas Headquarters

OSRAM SYLVANIA Inc.

200 Ballardvale Street

Wilmington, MA 01887 USA

Phone 1-800-LIGHTBULB (1-800-544-4828)

www.osram-america.com

OSRAM and LIGHTIFY are registered trademarks of OSRAM GmbH.
LED CREATING TOMORROW is a registered trademark of OSRAM GmbH.
Google Play is a trademark of Google Inc.
Apple, the Apple logo and iPhone are trademarks of Apple Inc.
App Store is a service mark of Apple Inc.
Zigbee is a registered trademark of Zigbee Alliance.
Specifications subject to change without notice.



LIGHTIFY® RT5/6 LED

RGBW Recessed Downlight Kit



Key Features & Benefits

- Lumen package:
 - 820 lumens @ 13.5W
- CRI: 90+; R9>50
- Replaces 65W Incandescent BR30 lamp
- Fits in standard 5 or 6" recessed downlight fixtures
- Tunable White; 1900K-6500K
- Full color control
- 20,000 hours rated life (L₇₀)
- Suitable for dry and damp locations
- 120 input voltage
- Lasts up to 10 times longer than incandescent lamps
- No warm-up time, instant-on with full light output and stable lamp to lamp color
- Integrated white trim and metal conduit adaptor (included) for direct replacement

Light has never been so enriching, helpful, individual and networked. OSRAM LIGHTIFY brings the future of lighting into your home or business today. Experience intelligent, connected solutions that adapt at any time to your desires and lifestyle easily via existing mobile devices and a free, simple-to-use app.

The LIGHTIFY lighting system begins with a wireless Gateway (sold separately or in starter kit) that can be plugged into a standard wall outlet anywhere in your home or business, and wirelessly syncs with your existing WiFi network. The LIGHTIFY LED RT5/6 has a broad range of CCT from a 1900K all the way up to 6500K. The free, user-friendly LIGHTIFY App, which runs on Apple iOS7 or above and Android 4.1 or above, offers a variety of practical and playful options to control the lighting system and is simple to use, convenient and secure.

Product Offering

Ordering Abbreviation	Wattage	Lumens	CCT
LED RT5/6 RGBW	13.5	820	1900K-6500K

Application Information

Application Notes

1. LIGHTIFY RT5/6 requires ZigBee Certified Gateway (Sold separately)
2. Product activation requires active WiFi Network and ZigBee Certified Gateway (must be place in range of wireless router)
3. Free LIGHTIFY App runs on Apple iOS7 or above and Android 4.1 or above
4. 2 year limited product warranty. Operating temperature range between -4°F and +104°F (-20°C and +40°C)
5. Suitable for use in indoor dry and damp location environments
6. Not intended for use with dimmers, emergency light fixtures or exit lights
7. Lamp dims via wireless control and will not operate with a dimmer switch, remove all existing dimmers and replace with a regular switch, leave lamp in ON position

Specifications and Certifications



Specification Data

Catalog #	Type
Project	
Comments	
Prepared by	

Ordering Information

Item Number	Ordering Description	Wattage	Lumens	CCT	CRI	Life
73741	LED13.5RT56RGB W LFY	13.5	820	1900K - 6500K	90+	20,000
73692	2.4GHZ/ZB/GATEWAY/LFY					

Ordering Guide

LED	13.5	RT56	RGBW	LFY
LED	Wattage: 13.5	Lamp Type RT5/6	Red, Green, Blue and Tunable White	LIGHTIFY

Assembly Diagram

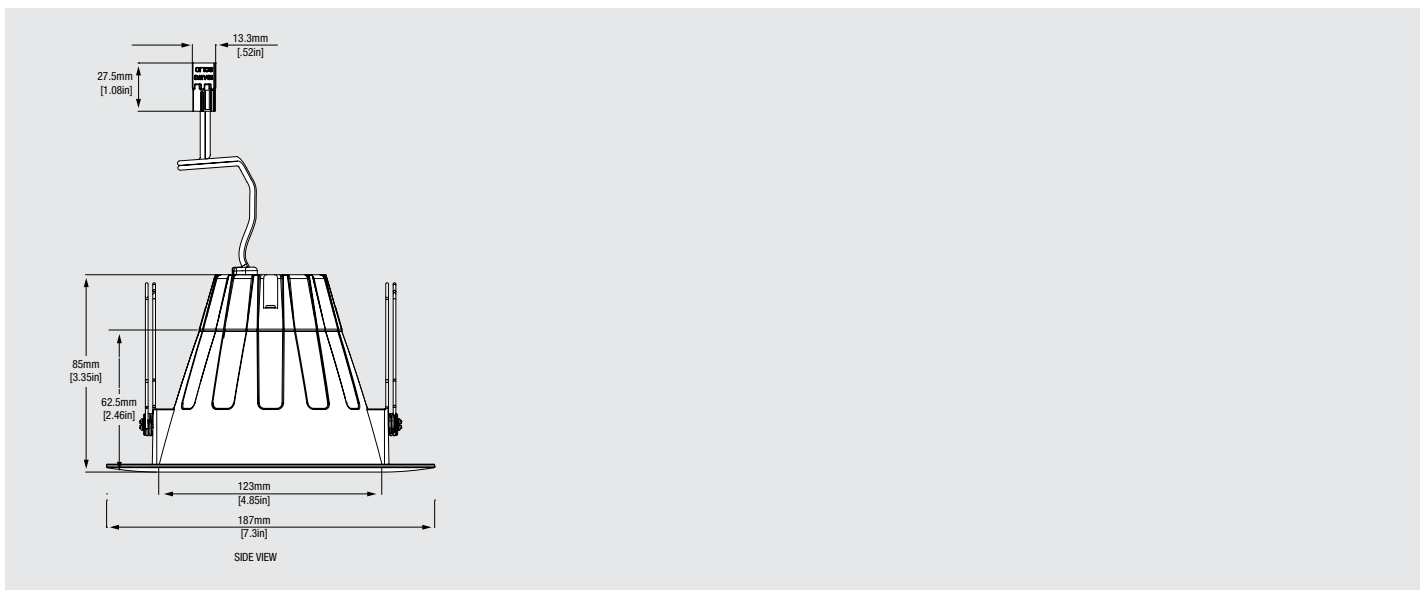

LIGHTIFY® App

LIGHTIFY App: Free download on any device which runs on Apple iOS7 or above and Android 4.1 or above

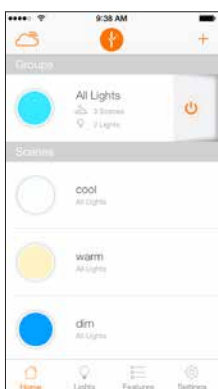

Scene Setting Dashboard

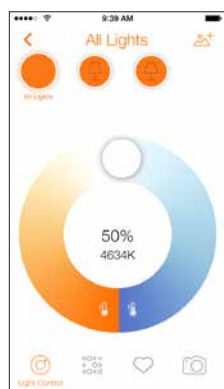

Tunable White Control



RGBW Color Control

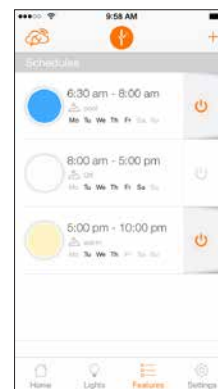

Set schedules
for your home

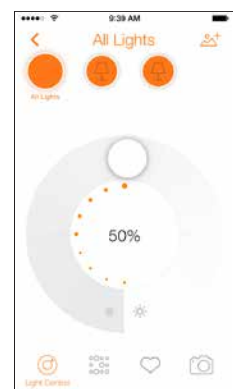

Dimmable Control

Photometric Distribution

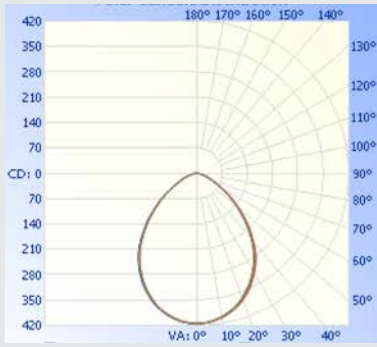

OSRAM

Americas Headquarters

OSRAM SYLVANIA Inc.

200 Ballardvale Street

Wilmington, MA 01887 USA

Phone 1-800-LIGHTBULB (1-800-544-4828)

www.osram-america.com

OSRAM is registered trademark of OSRAM GmbH.
LIGHTIFY and LED CREATING TOMORROW are registered trademarks of OSRAM GmbH.
Google Play is a trademark of Google Inc.
Apple, the Apple logo and iPhone are trademarks of Apple Inc.
App Store is a service mark of Apple Inc.
Zigbee is a registered trademark of Zigbee Alliance.
Specifications subject to change without notice.

